

Training
2024
MULTIVAC UK

2024 Training Courses

Below is the calendar of courses throughout the year; however the dates for availability are subject to change.

January						
M	T	W	T	F	S	S
1	2	3	4	5	6	7
8	9	10	11	12	13	14
15	16	17	18	19	20	21
22	23	24	25	26	27	28
29	30	31				

February						
M	T	W	T	F	S	S
			1	2	3	4
5	6	7	8	9	10	11
12	13	14	15	16	17	18
19	20	21	22	23	24	25
26	27	28	29			

March						
M	T	W	T	F	S	S
				1	2	3
4	5	6	7	8	9	10
11	12	13	14	15	16	17
18	19	20	21	22	23	24
25	26	27	28	29	30	31

April						
M	T	W	T	F	S	S
1	2	3	4	5	6	7
8	9	10	11	12	13	14
15	16	17	18	19	20	21
22	23	24	25	26	27	28
29	30					

May						
M	T	W	T	F	S	S
		1	2	3	4	5
6	7	8	9	10	11	12
13	14	15	16	17	18	19
20	21	22	23	24	25	26
27	28	29	30	31		

June						
M	T	W	T	F	S	S
					1	2
3	4	5	6	7	8	9
10	11	12	13	14	15	16
17	18	19	20	21	22	23
24	25	26	27	28	29	30

July						
M	T	W	T	F	S	S
1	2	3	4	5	6	7
8	9	10	11	12	13	14
15	16	17	18	19	20	21
22	23	24	25	26	27	28
29	30	31				

August						
M	T	W	T	F	S	S
			1	2	3	4
5	6	7	8	9	10	11
12	13	14	15	16	17	18
19	20	21	22	23	24	25
26	27	28	29	30		

September						
M	T	W	T	F	S	S
						1
2	3	4	5	6	7	8
9	10	11	12	13	14	15
16	17	18	19	20	21	22
23	24	25	26	27	28	29
30						

October						
M	T	W	T	F	S	S
	1	2	3	4	5	6
7	8	9	10	11	12	13
14	15	16	17	18	19	20
21	22	23	24	25	26	27
28	29	30	31			

November						
M	T	W	T	F	S	S
				1	2	3
4	5	6	7	8	9	10
11	12	13	14	15	16	17
18	19	20	21	22	23	24
25	26	27	28	29	30	31

December						
M	T	W	T	F	S	S
						1
2	3	4	5	6	7	8
9	10	11	12	13	14	15
16	17	18	19	20	21	22
23	24	25	26	27	28	29
30	31					

 Bank holiday

Calendar Key

Multi-skills – MULTIVAC Thermoformers IPC Control

Types 03, 05, 06

12:00 Monday to 13:00 Friday

Previous Generation Machine Course

R 120, R 140, R 170, R 240, R 530, R 570

12:00 Monday to 13:00 Friday

TX Tray Sealing Course

Courses booked on request

Courses on demand

Machine Minders and Line Leaders

Thermoformers

2 day course. 09:00 to 16:00 both days.

Slicer

Basic

Advanced

On site application training

TVI Course

GMS 1200, GMS520, GMS 1600, GMS 400

2 day course. 09:00 to 16:00 both days.

Advance control systems – Beckoff

2 day course. 09:00 to 16:00 both days.

In addition to the training course dates detailed in this brochure, MULTIVAC are also able to provide on-site training throughout the year. We can tailor courses or deliver completely bespoke courses for your business. Advanced courses can also be held throughout the year upon request.

For all training enquiries please contact training@multivac.co.uk
or call into 01793 425800 (option 1)

* Please note due to the high cost of cancellations, all courses require a PO Number as confirmation of booking (Including FOC places).
If the places are cancelled within 14 days of the course date, full charges will apply.

Welcome

Welcome to MULTIVAC UK's 2024 Training brochure, where you will find information on our range of training courses for both Engineer and Operator training.

We are pleased to offer training courses across our full range of Packaging, Processing, Slicing and Bakery equipment. Our courses focus on optimising machine performance, minimising machine downtime and increasing throughput and yield.

In addition to the courses detailed in this brochure, we are also able to offer bespoke training courses designed to suit your business's specific needs. All courses, both Engineer and Operator focused, are available at our purpose-built Training facility in Swindon or locally at your site, utilising classroom as well as practical machine sessions.

MULTIVAC is at the forefront of technology when it comes to training. We use high-performance digital tablets to aid training which can be used for notes, documents and videos, as well as interactive quiz.

The digital tablets are the attendees' to take away and can be uploaded with machine drawings, service manuals or parts lists for the machines at your sites. The use of tablets has also helped to reduce our carbon footprint by reducing printed paper-based training manuals.

Why not find out how your business and OEE (Overall Equipment Effectiveness) can benefit from a MULTIVAC training course? Train your Engineering and Operator teams to help maintain the efficiency of your equipment to ensure the maximum lifespan of your valuable and essential assets.

Our Field Service Team now stands at 65 Technicians across the UK, organised into 5 regional teams to ensure the quickest reaction times from initial contact to attendance on site.

We look forward to working in partnership with you in 2024, to help train your team in the best maintenance, operation and optimisation of your MULTIVAC equipment.

A portrait of Keith Singleton, a middle-aged man with short, light-colored hair, wearing a dark jacket over a white collared shirt. He is smiling slightly and looking directly at the camera. The portrait is framed by a thick blue border that curves around the top and left sides.

Keith Singleton
Technical Director MULTIVAC UK

Meet the Trainers



Paul Wickenden
Technical Training Officer

"Having worked at MULTIVAC UK for over 30 years, I originally began my career as a Service Technician on the road for the first 14 years. After moving to the Service Office and eventually to the Training department I now deliver training courses to around 250 engineers and operators a year at our Swindon facility."



Luke Brownsword
TVI Training Officer

"I have worked with TVI equipment for around 7 years and am pleased to help provide MULTIVAC's training courses for the TVI product range. Having spent the first 5 years as a Service Technician, I now deliver training courses to customers and fellow service technicians from the UK and around the world."



Matt Astley
TX Training Officer

"I have been working with MULTIVAC for 18 years now. Over the years I've worked on a wide range of our machines. Having gained experience over that period of time I am now pleased to give training to our customers and technicians."

Testimonials

"It was a very good and useful course. It has made me feel more safe and confident when working on MULTIVAC machines in the future" – [Engineer, Norseland](#)

"The training I received was brilliant, and the trainer was exceptional in all areas of the course" – [Electrical Engineer, ABP](#)

"Excellent course! MULTIVAC machines are relatively new to me but I now feel more confident working with them after my training course" – [Engineering Shift Manager, Ornuva Foods Ltd](#)

"The course was excellent and I would definitely recommend this to my colleagues. The trainer communicated all areas of the course really well and was very knowledgeable" – [Engineer, Arla Foods](#)

"The course has improved my knowledge and understanding of how MULTIVAC machines work and has also improved my confidence when working with the machines" – [Engineer, Mowi](#)



Contents

Multi-skills – MULTIVAC Thermoformers IPC Control	8
Multi-skills – Previous Generation of MULTIVAC Thermoformers	9
Traysealers	10
TVI	11
Line Leaders and Machine Minders	12
MR Labellers and Printers	13
Onsite Training	14
Onsite TVI Engineers	15
Onsite TVI Advanced Engineers	16
Onsite TVI Advanced Operators	17
Onsite S 800 Slicing Training course	18
Advanced Control Systems Beckhoff	19
MULTIVAC Workshop	20
Spares Department	21
Proactive Maintenance Plans	23
Accommodation	24
How to find us	25
About MULTIVAC UK	26
The MULTIVAC Advantage	27

Multi-skills – MULTIVAC Thermoformers

IPC Control

Who is it for?

Competent Electrical or Mechanical Engineers with at least 1 months experience operating MULTIVAC machinery.

Course content

- Safety guards and emergency stop circuits
- IPC control panel
- Forming processes
- Sealing station
- Beckhoff PLC and flashcard
- Pneumatic and vacuum valves
- Different film types and properties
- Required machine maintenance
- Electrical and pneumatic circuit drawings
- Cutting equipment
- Advance systems
- Die changes and adjustments
- Fault finding
- Graded examination to complete course

Benefits

- Safe and confident around the whole machine
- Create new programmes and save them to memory
- In-depth understanding of the electrical, pneumatic and vacuum systems and technical drawings
- In-depth understanding of all machine functions and key components
- Optimum machine performance
- Reduced downtime through rapid fault finding

Stainless Steel Thermoforming Machines	Delegates	Duration	Fee per person
R 105, R 125 / 126, R 145, R 155, R 175 MF, R 225, R 245, R 255, R 275 MF, R 535, R 575 MF, RX	8	4 days	£ 1,770 + VAT

Screen types covered on this course - IPC03/05/06/07/062G (before June 2023)

A buffet lunch is included in the course fee.

[Courses start 12:00 Monday and complete 13:00 Friday](#)

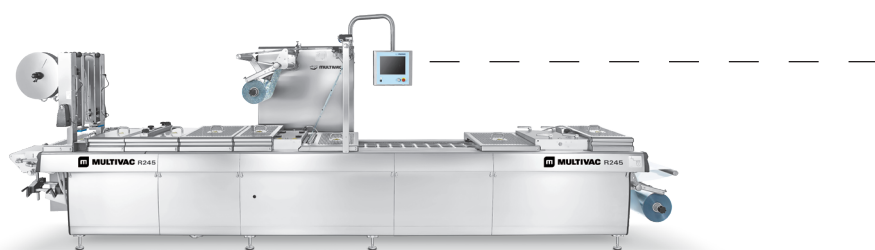

▲ MULTIVAC R 245 Thermoformer

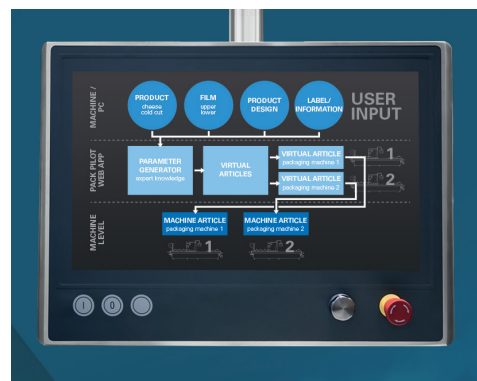

All courses require a 100% booking fee which will be refunded with 14 days notice of cancellation before the course date.

For enquiries or to book: email training@multivac.co.uk or call 01793 425800

Multi-skills – Previous Generation of MULTIVAC Thermoformers

Who is it for?

Competent Electrical or Mechanical Engineers with at least 1 months experience operating MULTIVAC machinery.

Course content

- Safety guards and emergency stop circuits
- Machine control panel
- Forming processes
- Sealing station
- Pneumatic and vacuum valves
- Different film types and properties
- Required machine maintenance
- Electrical and pneumatic circuit drawings
- Cutting equipment
- Advance systems
- Die changes and adjustments
- Fault finding
- Graded examination to complete course

Benefits

- Safe and confident operation of the machine
- Create new programmes and save to memory
- In-depth understanding of electrical, pneumatic and vacuum systems and technical drawings
- In-depth understanding of all machine functions and key components
- Optimum machine performance
- Reduced downtime through basic fault finding

Stainless Steel Thermoforming Machines	Delegates	Duration	Fee per person
R 140, R 230, R 240, R 530, R 570	8	4 days	£ 1,770 + VAT

A buffet lunch is included in the course fee.

Courses start 12:00 Monday and complete 13:00 Friday



All courses require a 100% booking fee which will be refunded with 14 days notice of cancellation before the course date.

For enquiries or to book: email training@multivac.co.uk or call 01793 425800

TX Tray Sealers

Who is it for?

Competent Electrical or Mechanical Engineers with at least 1 months experience operating MULTIVAC machinery, who require an in-depth knowledge of MULTIVAC Traysealers.

Course content

- Safety guards and emergency stop circuits
- Machine control panel
- Sealing and cutting stations
- Die changes and adjustments
- Loading and die lifting systems
- Top web advance system
- Pneumatic and vacuum valves
- Different film types and properties
- Required machine maintenance
- Electrical and pneumatic circuit drawings
- Fault finding
- Graded examination to complete course

Benefits

- Safe and confident operation of the machine
- Create new programmes and save to memory
- In-depth understanding of electrical, pneumatic and vacuum systems and technical drawings
- In-depth understanding of all machine functions and key components
- Optimum machine performance
- Reduced downtime through basic fault finding

Machines	Delegates	Duration	Fee per person
MULTIVAC Traysealers	8	2 days	£ 980 + VAT

A buffet lunch is included in the course fee.

Course starting at 12:00 Tuesday to 13:00 Thursday.

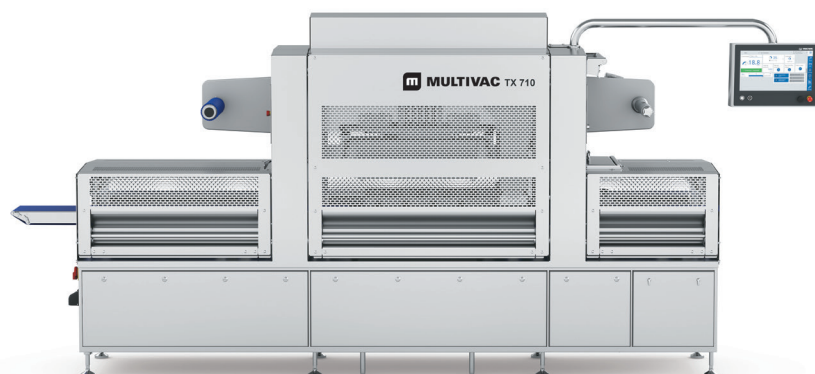

▲ MULTIVAC TX 710 Traysealer

All courses require a 100% booking fee which will be refunded with 14 days notice of cancellation before the course date.

For enquiries or to book: email training@multivac.co.uk or call 01793 425800

TVI

Who is it for?

Engineers with a basic knowledge of TVI GMS, with at least 6 months experience operating TVI equipment.

Course content

- Operation and programming of the machine
- Electrical and mechanical components
- Parameters and adjustments
- Practical strip-down of serviceable items
- Recommended tooling
- Accuracy and operational issues
- Knife sharpening
- Fault finding
- Graded examination to complete course

Benefits

- Safe and confident operation of the machine
- Create new programmes and save to memory
- In-depth understanding of electrical, pneumatic and vacuum systems and technical or schematic drawings
- In-depth understanding of all machine functions and key components
- Optimum machine performance
- Reduced downtime through basic fault finding

Machines	Delegates	Duration	Fee per person
TVI Portioning	4	2 days	£ 1,180 + VAT

A buffet lunch is included in the course fee.

[Basic 2 day course at MULTIVAC.](#)



▲ TVI GMS 1600



▲ TVI GMS 400

All courses require a 100% booking fee which will be refunded with 14 days notice of cancellation before the course date.

For enquiries or to book: email training@multivac.co.uk or call 01793 425800

Line Leaders and Machine Minders

Who is it for?

Line Leaders and Machine Minders who are responsible for the day-to-day operation of MULTIVAC machinery.

Course content

- Function and operation of emergency stop buttons
- Inspection of safety guards
- Side covers and interlocks
- Trim removal from transport chains
- Vacuum testing
- Heat impression in the forming die
- Safe cleaning of heater plates
- Die removal
- Basic machine maintenance
- Chain lubrication
- Air and water requirements and filter cleaning
- Testing transport chains for wear
- Rotary cutting devices
- Adjustments for improving pack quality and machine operation

Benefits

- Safe and confident operation of the machine
- Confident regulation and adjustment
- Optimum machine performance
- Reduced downtime through rapid fault finding

Machines	Delegates	Duration	Fee per person
MULTIVAC Thermoformers	8	2 days	£ 980 + VAT

A buffet lunch is included in the course fee.

Course starting at 09:00 the first day and completing for 16:00 on the last day



▲ MULTIVAC RX 4.0 Thermoformer

All courses require a 100% booking fee which will be refunded with 14 days notice of cancellation before the course date.

For enquiries or to book: email training@multivac.co.uk or call 01793 425800

MR Labellers and Printers

Who is it for?

Engineers who require basic training or Line Leaders and Maintenance personnel who require performance-enhancing or problem-solving skills.

Course content

- Safety guards and emergency stop systems
- Installation of labels and print ribbons
- Labeller control panel
- Printing station
- Creating print formats
- Different film types and properties
- Photo Electric Control (PEC) for top web alignment
- Electrical and pneumatic circuit drawings
- Graded examination to complete course

Benefits

- Safe and confident operation of the machine
- Create new programmes and save to memory
- In-depth understanding of all machine functions and key components
- Optimum machine performance
- Reduced downtime through basic fault finding

Machines	Delegates	Duration	Time	Fee per person
OP/UP Labellers, direct web printers, offline labellers and Zero-Downtime*	4	1 day	9 am – 5 pm	£ 530 + VAT

* Zero-Downtime Labelling courses will be run on customer's site

[Courses run on demand and mainly on-site](#)

Option: Onsite Training, £ 1,770 + VAT per day

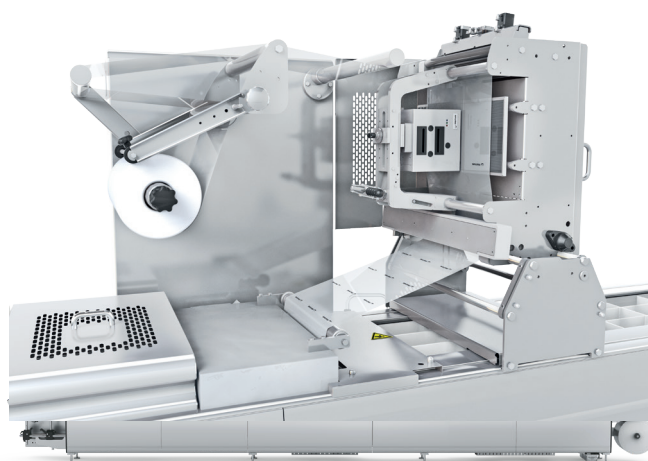

▲ MULTIVAC MR 293 Labeller

All courses require a 100% booking fee which will be refunded with 14 days notice of cancellation before the course date.

For enquiries or to book: email training@multivac.co.uk or call 01793 425800

Onsite Training

Objective

Onsite training is available on a range of MULTIVAC equipment. The specific objectives of these courses are determined by you. Typically, the course is designed to develop an understanding of the principles of MULTIVAC machinery in practice and to maintain production efficiency.

Who Is It For?

Production and Technical personnel who are responsible for the day-to-day operation of MULTIVAC machinery.

Course content

Tailored to meet your specific requirements

What is required?

A dedicated machine must be available as well as a room for theory and practical training. Training will be carried out by experienced MULTIVAC Technicians.

Machines	Delegates	Duration	Time	Fee per day
A dedicated machine must be available and a meeting room with display screen	4	1 day	9 am – 5 pm	£ 1,770 + VAT

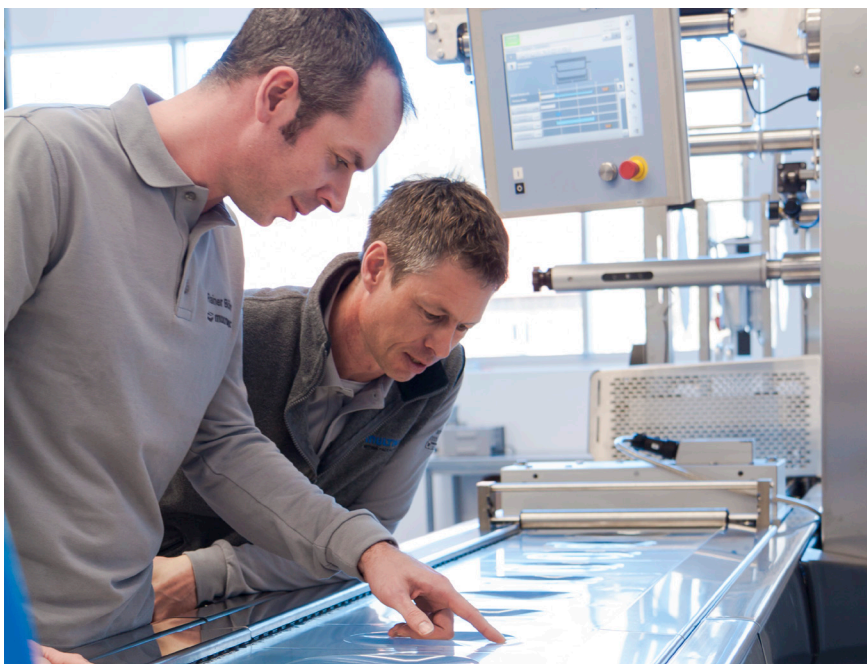

All courses require a 100% booking fee which will be refunded with 14 days notice of cancellation before the course date.

For enquiries or to book: email training@multivac.co.uk or call 01793 425800

Onsite TVI Engineers

Who is it for?

Site engineers who have access to settings pages, wanting to gain a better understanding of machine settings with a focus on troubleshooting.

Access to a machine is required, as well as a room for theory and practical training. No mechanical or electrical work shall be done on the machine during this course.

Course content

- In-depth review of settings
- In-depth review of line processes and the effect of external factors
- Fault finding
- Checking for wear parts
- Use of HMI screen
- Basic troubleshooting
- Graded examination to complete the course

Benefits

- Safe and confident operation of the machine
- Create new programmes and save to memory
- In-depth understanding of electrical, pneumatic and vacuum systems and technical or schematic drawings
- In-depth understanding of all machine functions and key components
- Optimum machine performance
- Reduced downtime through basic fault finding

Machines	Delegates	Duration	Time	Fee per day
TVI	4	1 day	9 am – 5 pm	£ 1,770 + VAT

All courses require a 100% booking fee which will be refunded with 14 days notice of cancellation before the course date.

For enquiries or to book: email training@multivac.co.uk or call 01793 425800

Onsite TVI Engineers

Who is it for?

Engineers who have previously attended the basic TVI training course, with at least one month since completing the course. A production machine must be available with product to showcase settings changes and optimisation improvements whilst in production. Downtime and issues will be kept to a minimum.

Course content

- Pre-assessment to understand current knowledge
- Overview of settings currently used to run the machine
- Practical demonstration with in-depth reasoning and understanding
- In-depth operation, including service pages
- Fault finding
- External factors and accuracy/operational issues
- Knife sharpening guidelines and incorrectly sharpened blades
- Processes of line
- Graded examination to complete the course

Benefits

- Safe and confident operation of the machine
- Create new programmes and save to memory
- In-depth understanding of electrical, pneumatic and vacuum systems and technical or schematic drawings
- In-depth understanding of all machine functions and key components
- Optimum machine performance
- Reduced downtime through basic fault finding

Machines	Delegates	Duration	Time	Fee per day
TVI	4	1 day	9 am – 5 pm	£ 1,890 + VAT

All courses require a 100% booking fee which will be refunded with 14 days notice of cancellation before the course date.

For enquiries or to book: email training@multivac.co.uk or call 01793 425800

Onsite TVI Advanced Operators

Who is it for?

Site operators who have access to settings pages, wanting to gain a better understanding of machine settings and optimisation.

Access to a machine is required, as well as a room for theory and practical training. No mechanical or electrical work shall be done on the machine during this course.

Course content

- In-depth review of settings
- In-depth review of line processes and the effect of external factors
- Fault finding
- Checking for wear parts
- Use of HMI screen
- Graded examination to complete the course

Benefits

- Safe and confident operation of the machine
- Create new programmes and save to memory
- In-depth understanding of electrical, pneumatic and vacuum systems and technical or schematic drawings
- In-depth understanding of all machine functions and key components
- Optimum machine performance
- Reduced downtime through basic fault finding

Machines	Delegates	Duration	Time	Fee per day
TVI	4	1 day	9 am – 5 pm	£ 1,650 + VAT

All courses require a 100% booking fee which will be refunded with 14 days notice of cancellation before the course date.

For enquiries or to book: email training@multivac.co.uk or call 01793 425800

Onsite S 800 Slicing Training course

Objective

Onsite training is available for the MULTIVAC S 800 Slicer. The specific objectives of these courses are determined by you. The course is designed to develop an understanding Of the principles of slicing and to maintain production efficiency.

Who is it for?

Production and Technical personnel who are responsible for the day – to - day operation of the S 800 slicer.

Course content

Tailored to meet your specific requirements.

What is required?

A dedicated machine must be available for the duration of the course. The training will be delivered by an experienced MULTIVAC Technician.

	Delegates	Duration	Time	Fee per day
Operators course	4	1-2 hours per session	9 am – 5 pm	£ 1,770 + VAT
Engineers course	4	4 hours per session	9 am – 5 pm	£ 1,770 + VAT

All courses require a 100% booking fee which will be refunded with 14 days notice of cancellation before the course date.

For enquiries or to book: email training@multivac.co.uk or call 01793 425800

Advanced Control Systems Beckhoff

Who is it for?

Competent Electrical Engineers who previously attended the MULTIVAC New Generation Multi-skills training course

Course content

- Covering IPC 05/06/07/062G/08
- Beckhoff Safety cards
- Input / Output cards
- Power cards
- Communication between extended Cabinets
- K-bus and Ethercat systems
- In-depth instructions with schematic drawings
- Navigation of the HMI
- Fault Finding sessions
- Using Faulty components

Benefits

- Working knowledge of the HMI
- Communication between cabinets
- In-depth understanding of the electrical systems
- The Safety system
- Reduced downtime through competent fault finding
- Optimum machine performance
- The Safety system

Machines	Delegates	Duration	Time	Fee per person
R145, R175, R245, R535, R575	6	2 days	9 am – 5 pm	£ 1,605 + VAT

All courses require a 100% booking fee which will be refunded with 14 days notice of cancellation before the course date.

For enquiries or to book: email training@multivac.co.uk or call 01793 425800

MULTIVAC Workshop

MULTIVAC UK can provide a range of engineering services to ensure total care of your equipment. These services can increase efficiency and profitability, and also extend the life of your MULTIVAC machine.

Engineering services

- Platten Refurbishment
- Die Lift Cart Repairs – standard testing certification
- STS Cutter Regrind
- Repair Components

For any enquiries about any repair, overhaul, conversion or refurbishments please call:

01793 425800

or

email: technicalhelpdesk@multivac.co.uk



Spares Department

We understand the importance of your MULTIVAC machine to your business which is why we offer you access to order spare parts 24/7, with a full range of delivery options.

We are open 5 days a week:

Monday-Friday: 08.30 am – 05.00 pm

Out of hours – Pin Code ref:

Monday-Friday: 07.30 am – 08.30 pm

Weekends: 08.30 am – 01.00 pm

Benefits

- 24/7 availability
- Your MULTIVAC machine list
- Exclusive online offers
- Up to date inventory
- 3D catalog and virtual drawings for your machines
- Simple repeat orders
- Overview of all current and completed spare parts orders
- MULTIVAC contact information
- Book training courses online
- Support

Customer Portal

MULTIVAC's innovative customer portal allows you to order spare parts from your personal machine list and easily repeat orders. Our Web Shop is a quick and easy way of accessing drawings and manuals for all your equipment.

To order spare parts simply:

For enquiries or to order spare parts,

email spares@multivac.co.uk

or

call **01793 425800**

You can also visit our webshop:

www.portal.multivac.com



MULTIVAC

Proactive Maintenance Plans

At MULTIVAC we want to make owning a Thermoforming packaging machine as easy and convenient as possible, which is why we have developed a range of Proactive Maintenance Plans to help ensure optimum performance and the smooth running of your machine.

A Proactive Maintenance Plan is an affordable investment to protect your machine from the most common causes of downtime and inefficiency. With a structured schedule, a maintenance plan can help reduce the risk of unplanned downtime due to unforeseen breakdowns and machine faults.

We believe that the Overall Equipment Effectiveness (OEE) of your MULTIVAC machine is important to your business, and previous experience has shown that a well-maintained machine with a maintenance plan can achieve a greater output compared to those without.

Benefits

Purchasing a MULTIVAC Proactive Maintenance Plan for your Thermoforming packaging machine provides a range of benefits, including:

- Reduced downtime and increased productivity
- Peace of mind; your machine is being maintained to the highest possible standard
- Substantial discount on all labour charges
- Free access to out of hours telephone support (exclusively available to customers with Proactive Maintenance Plans)
- Discount on any parts required for the Proactive Maintenance Plan
- Discount on any follow-up work identified as a result of a service visit
- Single point of contact for all tailored Proactive Maintenance Plans

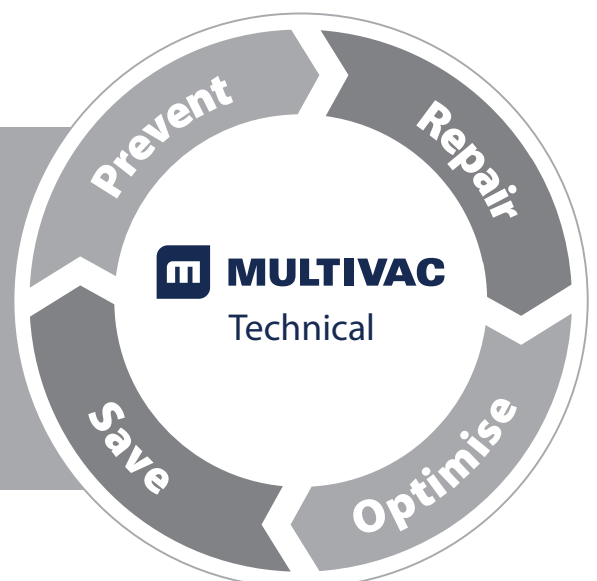

Accommodation

Please find below details of accommodation in the Swindon area. This list does not represent our recommendations, but merely offers a variety of price ranges available locally.

Early booking is advised

Please note that if hotels are fully booked and receive less than 24 hours notice of cancellation, they may reserve the right to charge the full room rate.

Please contact hotels direct to make a reservation

Most of these hotels now work on dynamic pricing models so these rates will change depending on when you book and how popular the days are. Please check direct with the hotel or their website.

Hotel	Approx miles from MULTIVAC	Address & Website	Tel Number
Cricklade House Hotel	7.5 miles	Common Hill, Cricklade, Swindon, Wiltshire SN6 6HA www.crickladehotel.co.uk	01793 750751
Jurys Inn	6.4 miles	Fleming Way, Swindon, SN1 2NG www.jurysinns.com	01793 849999
DoubleTree by Hilton Hotel	2.4 miles	Great Western Way, Swindon, Wiltshire SN5 8UZ www.doubletree3.hilton.com	01793 881777
Holiday Inn Express	2.4 miles	Frankland Rd, Swindon SN5 8UD www.expressswindon.co.uk	0871 902 1631
Blunsdon House Hotel	6 miles	The Ridge, Blunsdon, Swindon SN26 7AS www.blunsdonhouse.co.uk	01793 721701
Premier Inn	2.4 miles	Great Western Way, Swindon, Wiltshire SN5 8UY www.premierinn.com	0871 527 9068

Local Taxis

- V Cars – 01793 701701
- Radio Taxis – 01793 536666
- SN1 Cars – 01793 523523

How to find us

MULTIVAC UK

MULTIVAC House
 Rivermead Drive
 Rivermead
 Swindon
 Wiltshire
 SN5 7UY

T: +44 (0)1793 425800
 F: +44 (0)1793 616219
 W: www.multivac.co.uk

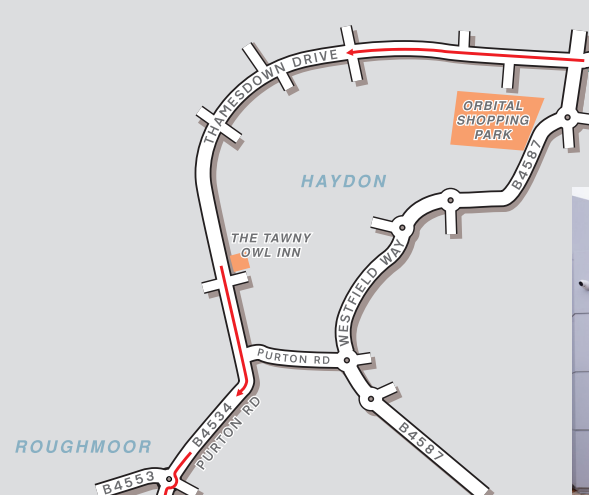
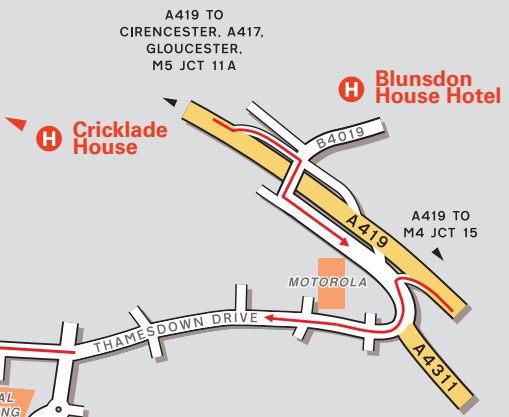

Public Transport

 **By Rail**
 Swindon Station
 Approximately 10 minutes taxi ride away. For information on train operators and times phone National Rail Enquiries on 0845 7484950.

 **By Air**
 Bristol Airport, Birmingham Airport & Heathrow Airport
 All approximately 1 hour 30 minutes drive away.

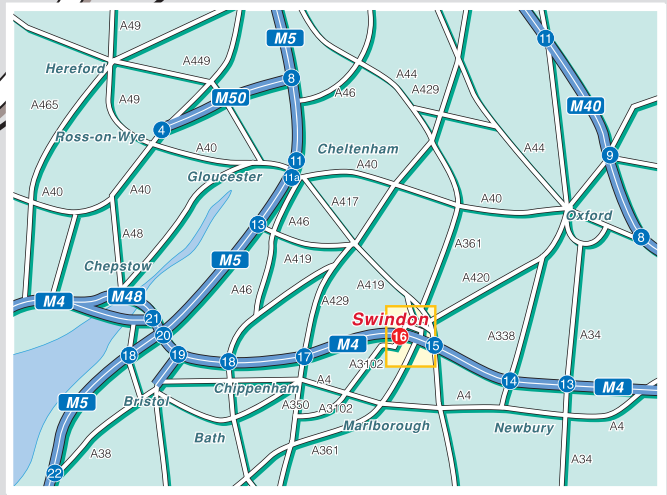
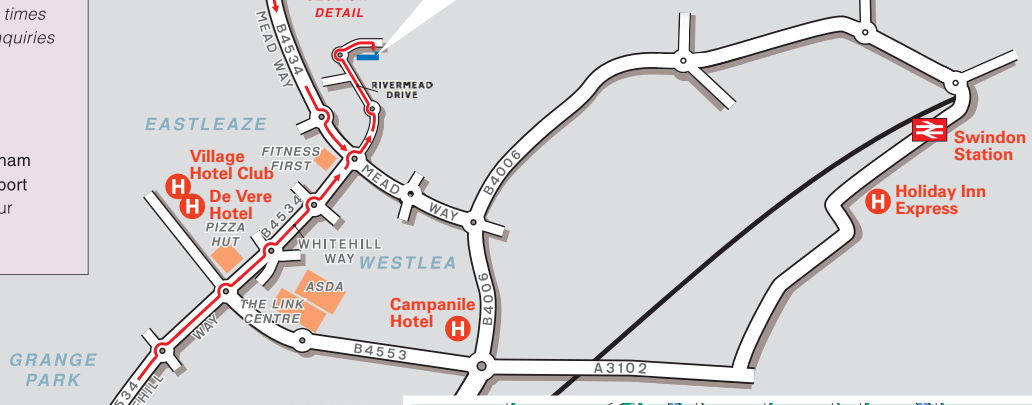

About MULTIVAC UK

MULTIVAC UK, based in Swindon, was founded in 1985 and is a daughter company of the MULTIVAC Group. As one of the global leading providers of packaging and processing for food, life, science, healthcare and industrial items, the MULTIVAC portfolio covers the complete packaging solution from upstream portioning and processing equipment to its well-known packaging technologies, automation solutions and end of line labelling and quality control systems.

MULTIVAC UK is also the produce exclusive UK agent for Risco, Laska and Schröter.



The MULTIVAC Advantage

- Project management services
- Proactive Maintenance Plans
- In-house manufacturing
- 55+ regionally based service engineers
- NDP facility within 850 m2 showroom
- Materials supply business
- Flexible finance solutions

MULTIVAC is one of the global leading providers of packaging and processing for food, life science, healthcare and industrial items.

The MULTIVAC portfolio covers the complete packaging solution from upstream portioning and processing equipment, to its well-known packaging technologies, automation solutions and end of line labelling and quality control systems.

MULTIVAC is able to provide all manufacturers' requirements in terms of pack design, output, resource efficiency, and after sales service.

